



Außenbeleuchtung ist viel mehr als nur funktional!

Dank integriertem Akku sind die transportablen Leuchten flexibel und setzen spannende Akzente im Garten, auf dem Balkon oder der Terrasse - ganz ohne Kabel! Für die richtige Stimmung sorgen zusätzliche Highlights wie RGB-Farbwechsler oder Bluetooth-Funktion für kabelloses Musik hören. Die perfekte Beleuchtung für gemeinsame Abendstunden mit Familie und Freunden.

Outdoor lighting is much more than just functional!

Integrated rechargeable batteries lets you flexibly use these easily transportable lights to accent your garden, balcony or terrace in an exciting way, all without any cables! Additional highlights like an RGB colour wheels and Bluetooth for streaming music wirelessly provide just the right mood. The perfect lighting for spending evening hours with family and friends.

L'éclairage extérieur est bien plus que simplement fonctionnel !

Grâce à la batterie rechargeable intégrée, les lampes transportables sont flexibles et mettent des accents excitants dans le jardin, sur le balcon ou la terrasse –

sans aucun câble ! D'autres fonctions marquantes garantissent une bonne ambiance, telles que le changeur de couleurs RVB ou la fonction Bluetooth pour l'écoute de musique sans fil. L'éclairage parfait pour les soirées partagées avec la famille et les amis.

Buitenverlichting is veel meer dan enkel nuttig!

Dankzij de geïntegreerde accu zijn de verplaatsbare lampen flexibel en zorgen voor mooie accenten in de tuin, op het balkon of op het terras, en dat helemaal zonder kabel! Voor de juiste stemming zorgen extra hoogtepunten zoals de RGB-kleurenwisselaar of Bluetooth-functie om draadloos muziek te beluisteren. De perfecte verlichting om 's avonds aangenaam te vertoeven met vrienden en familie.

¡La iluminación exterior es mucho más que algo funcional!

Gracias a la batería integrada, las luces transportables son flexibles y aportan puntos de atención excitantes al jardín, al balcón o a la terraza - ¡y sin ningún tipo de cables! Se consigue el ambiente adecuado con otras características especiales adicionales como el modificador de color RGB o la función Bluetooth para escuchar música sin cables. La iluminación perfecta para pasar la tarde con la familia y los amigos.



L'illuminazione esterna è molto più che funzionale!

Grazie alla batteria ricaricabile integrata, le lampade portatili sono flessibili e creano accenti emozionanti in giardino, sul balcone o sulla terrazza - senza cavi! Ulteriori punti di forza come il cambiacolori RGB o la funzione Bluetooth per l'ascolto di musica senza fili assicurano il giusto feeling. L'illuminazione perfetta per le ore serali da trascorrere insieme alla famiglia e agli amici.

Iluminarea exterioară este mult mai mult decât funcțională!

Datorită acumulatorului integrat, lămpile transportabile sunt flexibile și oferă un aspect atrăgător în grădină, pe balcon sau pe terasă - fără cablu! Atmosfera potrivită este asigurată de jocurile suplimentare de lumină cum ar fi schimbarea culorilor RGB sau funcția Bluetooth pentru a asculta muzică fără cablu. Iluminarea perfectă pentru orele de seară cu familia și prietenii.

Ulkovalaistus on paljon muutakin kuin vain toimintaa!

Integroidun ladattavan akun ansiosta siirrettävät valaisimet ovat joustavia ja muodostavat jännittäviä korostuksia puutarhaan, parvekkeelle tai terassille - ilman kaapeleita! Lisäkorostukset, kuten RGB-värvinvaihtajat tai Bluetooth-toiminto langattomaan musiikin kuuntelun, takaavat oikean ilmapiirin. Täydellinen valaistus illanviettoon yhdessä perheen ja ystävien kanssa.

Oświetlenie zewnętrzne to znacznie więcej niż tylko funkcjonalność!

Dzięki akumulatorowi przenośne lampy są elastyczne w ustawieniu i tworzą ekscytujące akcenty w ogrodzie, na balkonie lub tarasie - bez żadnych kabli! Odpowiedni nastrój zapewnią dodatkowe urządzenia, takie jak zmienne kolorów RGB lub funkcja Bluetooth do bezprzewodowego słuchania muzyki. Doskonałe oświetlenie wspólnych wieczorów z rodziną i przyjaciółmi.

PALMAS

Kunststoff
plastic
plastique
kunststof
plástico
plastica
plastic
muovi
plastik

01 Weiß · white

Incl. 1 x RGBW-LED, 1,5 W
45 lm, 3.000 K

R55101101

Incl. 1 x RGBW-LED, 3 W
90 lm, 3.000 K

R45101101

Incl. 1 x RGBW-LED, 4,5 W
120 lm, 3.000 K

R45101901



R55101101



R45101101



R45101901

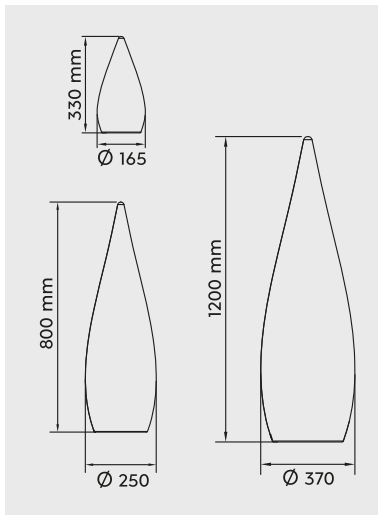

RGBW Farbwechsler
RGBW Colorchanging
Changement de couleur RGBW
RGBW Kleurverandering
Cambio de color RGBW
Cambia colore RGBW
Schimbator de culoare RGBW
Väriinvaihto RGB
Zmieniający kolor RGBW



Akkubetrieb
Rechargeable battery operated
Fonctionnement sur batteries rechargeable
Opladbare accu
Batería recargable
Batteria Ricaricabile
Operabil prin baterie reincarcabila
Ladattava akku
Akumulator zasilany bateryjnje
Şarj edilebilir pilli



Ladezeit
Charging time
Temps de charge
Oplaaftijd
Tiempo de carga
Tempo di carica
Timp de incarcare
Latausaika
Czas ładowania



Leuchtdauer
Luminous period
Durée d'éclairage
Brandtijd
Tiempo de iluminación
Tempo di durata
Perioada de iluminare
Valaistusaika
Czas świecenia

BERMUDA

Kunststoff
plastic
plastique
kunststof
plástico
plastica
plastic
muovi
plastik

01 Weiß · white

Incl. 1 x RGBW-LED, 1 W
35 lm, 3.000 K

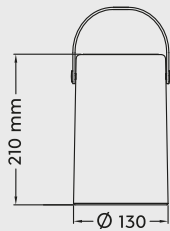

LIGHT & SOUND



R55060101



Bluetooth Lautsprecher
Bluetooth loudspeaker
Haut-parleur bluetooth
Bluetooth luidspreker
Altavoz de bluetooth
Altoparlante bluetooth
Difuzor Bluetooth
Bluetooth-kaiutin
Głośnik Bluetooth



Ladezeit
Charging time
Temps de charge
Oplaadtijd
Tiempo de carga
Tempo di carica
Timp de incarcare
Latausaika
Czas ładowania



Leuchtdauer
Luminous period
Durée d'éclairage
Brandtijd
Tiempo de iluminación
Tempo di durata
Perioada de iluminare
Valaistusaika
Czas świecenia

JAMAICA

Kunststoff
plastic
plastique
kunststof
plástico
plastica
plastic
muovi
plastik

01 Weiß · white

Incl. 1 x RGBW-LED, 2,5 W
25 lm, 3.000 K

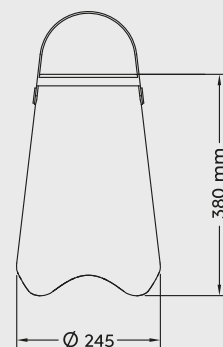

LIGHT & SOUND



R55086101

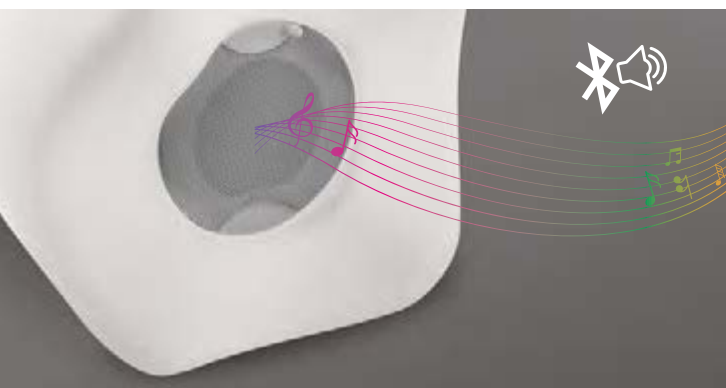

ARUBA

Kunststoff
plastic
plastique
kunststof
plástico
plastica
plastic
muovi
plastik

01 Weiß · white

Incl. 1 x RGBW-LED, 1 W
70 lm, 3.000 K

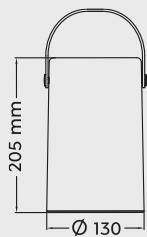

R57080101



RGBW Farbwechsler
RGBW Colorchanging
Changement de couleur RGBW
RGBW Kleurverandering
Cambio de color RGBW
Cambia colore RGBW
Schimbator de culoare RGBW
Väriinvaihto RGB
Zmieniający kolor RGBW



USB Anschluss mit Ladefunktion
Recharging USB connection
Entrée USB de rechargement
Opladende USB aansluiting
Conexión USB de recarga
Connessione USB di ricarica
Conexiune USB reîncărcare
Lataaminen USB-liitäntä
Ładowania USB połączenie
șarj USB baġlantı

HAITI



R57090101

Kunststoff
plastic
plastique
kunststof
plástico
plastica
plastic
muovi
plastik

01 Weiß · white

Incl. 1 x RGBW-LED, 1 W
70 lm, 3.000 K

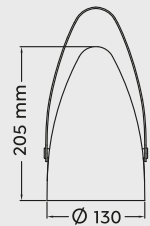

Ladezeit
Charging time
Temps de charge
Oplaadtijd
Tiempo de carga
Tempo di carica
Timp de incarcare
Latausaika
Czas ładowania



Leuchtdauer
Luminous period
Durée d'éclairage
Brandtijd
Tiempo de iluminación
Tempo di durata
Perioada de iluminare
Valaistus aika
Czas świecenia



HAWAII

Kunststoff
plastic
plastique
kunststof
plástico
plastica
plastic
muovi
plastik

01 Weiß · white

Incl. 1 x RGB-LED, 1,5 W
60 lm, 3.000 K

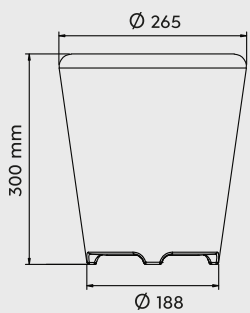
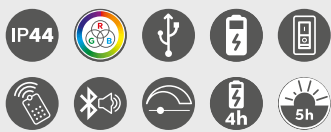

LIGHT & SOUND



R55096101



Bluetooth Lautsprecher
Bloutooth loudspeaker
Haut-parleur bluetooth
Bluetooth luidspreker
Altavoz de bluetooth
Altoparlante bluetooth
Difuzor Bluetooth
Bluetooth-kaiutin
Głośnik Bluetooth



Ladezeit
Charging time
Temps de charge
Oplaadtijd
Tiempo de carga
Tempo di carica
Timp de incarcare
Latausaika
Czas ładowania



Leuchtdauer
Luminous period
Durée d'éclairage
Brandtijd
Tiempo de iluminación
Tempo di durata
Perioada de iluminare
Valaistusaika
Czas świecenia

Kunststoff
plastic
plastique
kunststof
plástico
plastica
plastic
muovi
plastik

01 Weiß · white

Incl. 1 x SMD-LED, 1,5 W
130 lm, 3.000 K

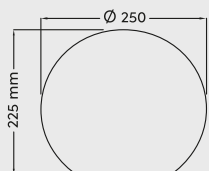
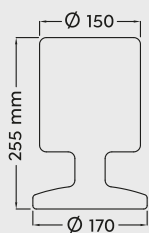

BARBADOS

R57010101



BAHAMAS

R57020101



Ladezeit
Charging time
Temps de charge
Oplaaadtijd
Tiempo de carga
Tempo di carica
Timp de incarcare
Latausaika
Czas ładowania



Leuchtdauer
Luminous period
Durée d'éclairage
Brandtijd
Tiempo de iluminación
Tempo di durata
Perioada de iluminare
Valaistusaika
Czas świecenia



DORA
R57051101

LORA
R57071101

Kunststoff
plastic
plastique
kunststof
plástico
plastica
plastic
muovi
plastik

01 Weiß · white

Incl. 1 x SMD-LED, 1,5 W
90 lm, 3.000 K

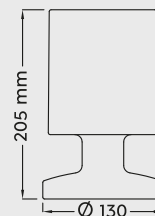
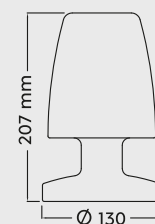

Akkubetrieb
Rechargeable battery operated
Fonctionnement sur batteries rechargeable
Oplaadbare accu
Batería recargable
Batteria Ricaricabile
Operabil prin baterie reincarcabila
Ladattava akku
Akumulator zasilany bateryjnje



USB Anschluss mit Ladefunktion
Recharging USB connection
Entrée USB de rechargement
Opladende USB aansluiting
Conexión USB de recarga
Connessione USB di ricarica
Conexiune USB reîncărcare
Lataaminen USB-liitäntä
Ładowania USB połączenie

DOMINGO

Metall, Kunststoff
metal, plastic
metale, plastique
metaal, kunststof
metal, plástico
metallo, plastica
metal, plastic
metalli, muovi
metal, plastik

42 Anthrazit · anthracite

Incl. 1 x SMD-LED, 2 W
150 lm, 3.000 K

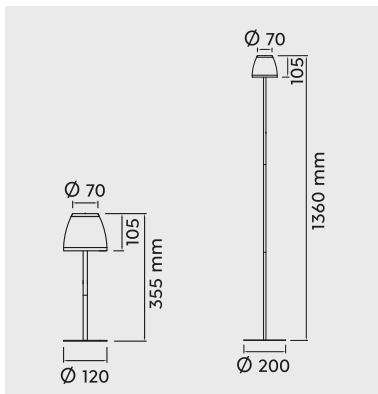

R52096142



R42096142



Ladezeit
Charging time
Temps de charge
Oplaadtijd
Tiempo de carga
Tempo di carica
Timp de incarcare
Latausaika
Czas ładowania



Leuchtdauer
Luminous period
Durée d'éclairage
Brandtijd
Tiempo de iluminación
Tempo di durata
Perioada de iluminare
Valaistusaika
Czas świecenia

LENNON



R52176101

Kunststoff
plastic
plastique
kunststof
plástico
plastica
plastic
muovi
plastik

01 Weiß · white
02 Schwarz · black

Incl. 1 x SMD-LED, 2 W
200 lm, 3.000 K

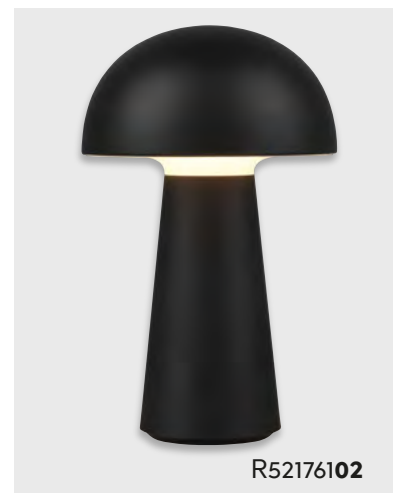
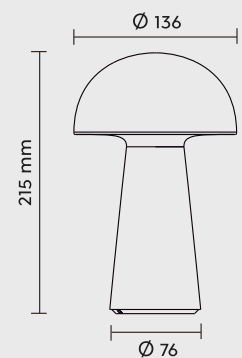

R52176102



Akkubetrieb
Rechargeable battery operated
Fonctionnement sur batteries rechargeable
Oplaadbare accu
Batería recargable
Batteria Ricaricabile
Operabil prin baterie reincarcabila
Ladattava akku
Akumulator zasilany bateryjnie



USB Anschluss mit Ladefunktion
Recharging USB connection
Entrée USB de rechargement
Opladende USB aansluiting
Conexión USB de recarga
Connessione USB di ricarica
Conexiune USB reîncărcare
Lataaminen USB-liitäntä
Ładowania USB połączenie



BOLO

Kunststoff
plastic
plastique
kunststof
plástico
plastica
plastic
muovi
plastik

01 Weiß · white

Excl. 1 x E27, max. 23 W

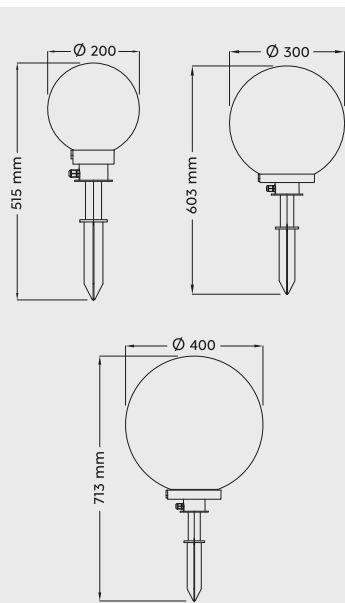

R57043001



R57042001



R57044001

Empfohlen:
recommended:

LED E27, 10 W
806 lm, 3.000 K



R988-90







Sonne Tanken!

Solarleuchten nutzen ausschließlich die Kraft der Sonne um Licht zu erzeugen. Dabei sind sie extrem umwelt-schonend, sparsam und gleichermaßen praktisch, da sie weder Steckdosen noch einen Anschluss ans Stromnetz benötigen. In Kombination mit moderner LED-Technik bieten Solarleuchten ideales Licht für Haus und Garten.

Soak up the sun!

Solar lamps exclusively use the power of the sun to generate light. At the same time they are extremely environmentally friendly and economical as well as practical, as they need neither sockets nor a connection to the mains supply. In combination with modern LED technology, solar lamps provide an ideal light for home and garden.

Faites le plein de soleil !

Les lampes solaires utilisent exclusivement l'énergie du soleil pour générer de la lumière. En même temps, elles sont extrêmement écologiques, économiques et tout aussi pratiques, car elles ne nécessitent ni prise de courant ni raccordement au réseau électrique. En combinaison avec la technologie LED moderne, les lampes solaires fournissent une lumière idéale pour la maison et le jardin.

Doe zon op!

Zonnelampen maken uitsluitend gebruik van de kracht van de zon om licht te produceren. Daarbij zijn ze extreem milieuvriendelijk, zuinig en in gelijke mate praktisch, omdat ze noch een stopcontact noch een aansluiting op het stroomnet nodig hebben. In combinatie met moderne ledtechniek bieden z onnelampen ideaal licht voor huis en tuin.

¡Disfrute del sol!

Las luces solares usan exclusivamente la energía del sol para generar luz. Al mismo tiempo, son extremadamente ecológicas, económicas e igualmente prácticas, y no necesitan ni enchufes ni conexión a la corriente. En combinación con las modernas técnicas LED, las luces solares ofrecen una luz ideal para la casa y el jardín.



Prendete un po' di sole!

Le lampade solari utilizzano esclusivamente la potenza del sole per generare luce. Allo stesso tempo sono estremamente rispettose dell'ambiente, economiche e pratiche in quanto non richiedono né presa di corrente, né un collegamento alla rete elettrica. In combinazione con la moderna tecnologia LED, le lampade solari forniscono una luce ideale per la casa e il giardino.

Alimentați cu soare!

Lămpile solare se folosesc în exclusivitate de energia soarelui pentru a genera lumină. În acest context sunt extrem de ecologice, economice și practice în același timp, deoarece nu necesită nici prize și nici conectarea la o rețea electrică. În combinație cu tehnologia modernă LED, lămpile solare oferă lumina ideală pentru casă și grădină.

Ajattele aurinkoa!

Aurinkovalaisimet käyttävät auringon energiaa valon tuottamiseen. Samalla ne ovat erittäin ympäristöystävällisiä, taloudellisia ja myös käytännöllisiä, koska ne eivät vaadi pistorasioita tai liitännää sähköverkkoon. Yhdessä modernin LED-tekniikan kanssa aurinkovalaisimet tarjoavat ihanteellisen valaistuksen kotiin ja puutarhaan.

Nałapać energii słonecznej!

Lampy solarne wykorzystują moc słońca do generowania światła. Są one przy tym niezwykle przyjazne dla środowiska, ekonomiczne i jednocześnie praktyczne, ponieważ nie wymagają gniazd ani podłączenia do sieci elektrycznej. W połączeniu z nowoczesną technologią LED lampy solarne zapewniają idealne oświetlenie domu i ogrodu.

MINEROS

Kunststoff
plastic
plastique
kunststof
plástico
plastica
plastic
muovi
plastik

01 Weiß · white
11 Grau · grey

Incl. SMD-LED, 0,02 W



R55256101



R55256901

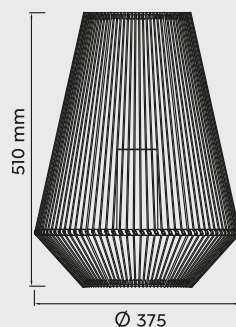
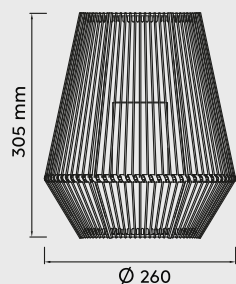

R55256911



R55256111



Ladezeit
Charging time
Temps de charge
Oplaadtijd
Tiempo de carga
Tempo di carica
Timp de incarcare
Latausaika
Czas ładowania



Leuchtdauer
Luminous period
Durée d'éclairage
Brandtijd
Tiempo de iluminación
Tempo di durata
Perioada de iluminare
Valaistus aika
Czas świecenia



Dämmerungssensor
Dusk sensor
Détecteur de crépuscule
Schemeringsensor
Sensor de oscuridad
Sensore crepuscolare
Senzor de lumina/amurg
Hämärätunnistin
Czujnik zmierzchowy



Flammen-Effekt
Flame effect
Effet de flamme
Vlammeneffect
Efecto de llamas
Effetto fiamma
Efect de flacără
Liekkitehoste
Efekt płomienia

VINTO

Kunststoff
plastic
plastique
kunststof
plástico
plastica
plastic
muovi
plastik

44 Beige · fawn

Incl. SMD-LED, 0,1 W
R55276144



Incl. SMD-LED, 0,2 W
R55276944

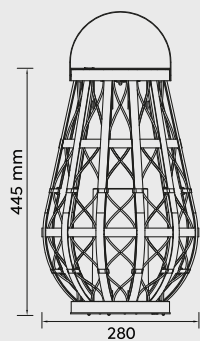
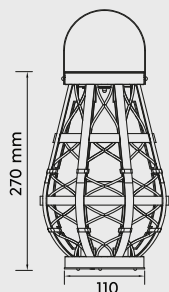

R55276144



R55276944



Ladezeit
Charging time
Temps de charge
Oplaadtijd
Tiempo de carga
Tempo di carica
Timp de incarcare
Latausaika
Czas ładowania



Leuchtdauer
Luminous period
Durée d'éclairage
Brandtijd
Tiempo de iluminación
Tempo di durata
Perioada de iluminare
Valaistusaika
Czas świecenia





MONTERO

Metall
metal
metale
metaal
metal
metallo
metal
metalli
metal

31 Weiß matt · white mat

88 Silber antik · antique silver

Incl. SMD-LED, 0,1 W

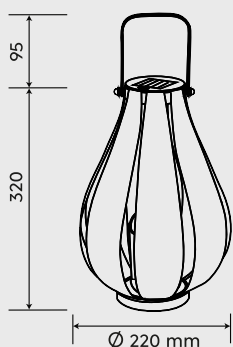

R55266131



R55266188



Ladezeit
Charging time
Temps de charge
Oplaaadtijd
Tiempo de carga
Tempo di carica
Timp de incarcare
Latausaika
Czas ładowania



Leuchtdauer
Luminous period
Durée d'éclairage
Brandtijd
Tiempo de iluminación
Tempo di durata
Perioada de iluminare
Valaistus aika
Czas świecenia

ARBIETO

Kunststoff
plastic
plastique
kunststof
plástico
plastica
plastic
muovi
plastik

42 Anthrazit · anthracite

Incl. SMD-LED, 0,02 W

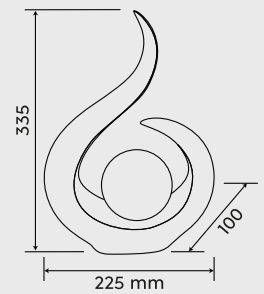

R55296142



Dämmerungssensor
Dusk sensor
Décteur de crépuscule
Schemeringsensor
Sensor de oscuridad
Sensore crepuscolare
Sensor de lumina/amurg
Hämärätunnistin
Czujnik zmierzchowy



Flammen-Effekt
Flame effect
Effet de flamme
Vlammeneffect
Efecto de llamas
Effetto fiamma
Efect de flacără
Liekkitehoste
Efekt płomienia



CAMIRI

Metall
metal
metale
metaal
metal
metallo
metal
metalli
metal

62 Kupfer antik · antique copper

88 Silber antik · antique silver

Incl. SMD-LED, 0,02 W

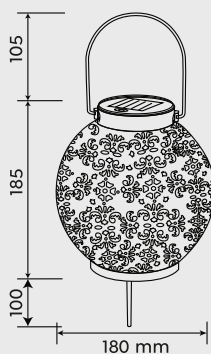

R55286188



R55286162



Ladezeit
Charging time
Temps de charge
Oplaadtijd
Tiempo de carga
Tempo di carica
Timp de incarcare
Latausaika
Czas ładowania



Leuchtdauer
Luminous period
Durée d'éclairage
Brandtijd
Tiempo de iluminación
Tempo di durata
Perioada de iluminare
Valaistusaika
Czas świecenia

COTOCA

Metall
metal
metale
metaal
metal
metallo
metal
metalli
metal

32 Schwarz matt · black mat

Incl. SMD-LED, 0,01 W

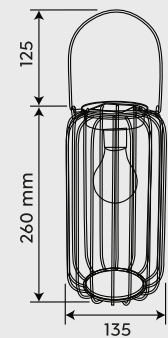

R55316132



Dämmerungssensor
Dusk sensor
Décteur de crépuscule
Schemeringsensor
Sensor de oscuridad
Sensore crepuscolare
Sensor de lumina/amurg
Hämärätunnistin
Czujnik zmierzchowy



Flammen-Effekt
Flame effect
Effet de flamme
Vlammeneffect
Efecto de llamas
Effetto fiamma
Efect de flacără
Liekkitehoste
Efekt płomienia



Kunststoff
plastic
plastique
kunststof
plástico
plastica
plastic
muovi
plastik

26 Braun · brown
32 Schwarz matt · black mat

Incl. SMD-LED, 0,1 W
R55196126



Incl. SMD-LED, 0,2 W
R55146132

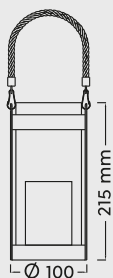

CARMELO
R55196126



MINAS
R55146132



Flammen-Effekt
Flame effect
Effet de flamme
Vlammeneffect
Efecto de llamas
Effetto fiamma
Efect de flacără
Liekkitehoste
Efekt płomienia

CORO

Metall, Kunststoff
metal, plastic
metale, plastique
metaal, kunststof
metal, plástico
metallo, plastica
metal, plastic
metalli, muovi
metal, plastik

32 Schwarz matt · black mat

Incl. SMD-LED, 0,2 W

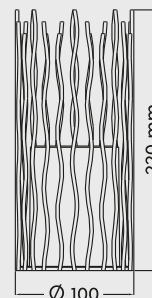

R55136132



Ladezeit
Charging time
Temps de charge
Oplaadtijd
Tiempo de carga
Tempo di carica
Timp de incarcare
Latausaika
Czas ładowania



Leuchtdauer
Luminous period
Durée d'éclairage
Brandtijd
Tiempo de iluminación
Tempo di durata
Perioada de iluminare
Valaistusaika
Czas świecenia

Kunststoff
plastic
plastique
kunststof
plástico
plastica
plastic
muovi
plastik

32 Schwarz matt · black mat

Incl. SMD-LED, 0,24 W



PARRAL

R55166132

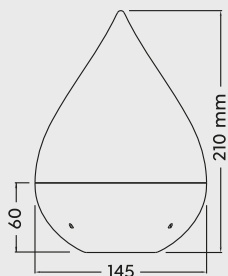
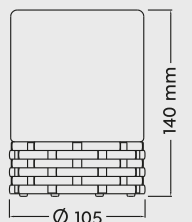

CALDERA

R55156132



Flammen-Effekt
Flame effect
Effet de flamme
Vlammeneffect
Efecto de llamas
Effetto fiamma
Efect de flacără
Liekkitehoste
Efekt plomienia





R55176132

Metall, Kunststoff
metal, plastic
metale, plastique
metaal, kunststof
metal, plástico
metallo, plastica
metal, plastic
metalli, muovi
metal, plastik

32 Schwarz matt · black mat

Incl. SMD-LED, 0,1 W

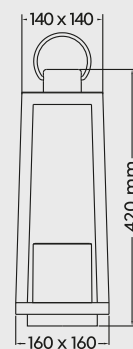

Ladezeit
Charging time
Temps de charge
Oplaadtijd
Tiempo de carga
Tempo di carica
Timp de incarcare
Latausaika
Czas ładowania



Leuchtdauer
Luminous period
Durée d'éclairage
Brandtijd
Tiempo de iluminación
Tempo di durata
Perioada de iluminare
Valaistusaika
Czas świecenia

MELO

Kunststoff
plastic
plastique
kunststof
plástico
plastica
plastic
muovi
plastik

01 Weiß · white

Incl. 1 x RGBW-LED, 0,5 W

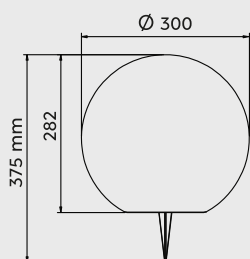
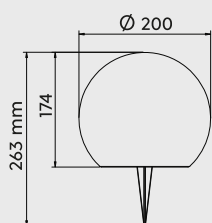

R55326901

R55326101

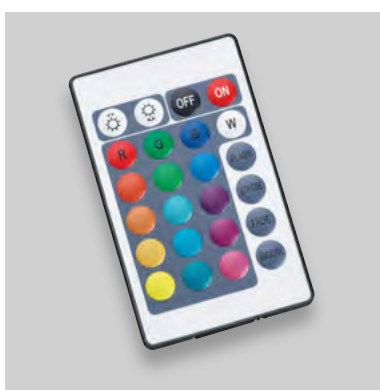

RGBW Farbwechsler
RGBW Colorchanging
Changement de couleur RGBW
RGBW Kleurverandering
Cambio de color RGBW
Cambia colore RGBW
Schimbator de culoare RGBW
Värvaihto RGB
Zmieniający kolor RGBW



Ladezeit
Charging time
Temps de charge
Oplaaadtijd
Tiempo de carga
Tempo di carica
Timp de incarcare
Latausaika
Czas ładowania



Leuchtdauer
Luminous period
Durée d'éclairage
Brandtijd
Tiempo de iluminación
Tempo di durata
Perioada de iluminare
Valaistusaika
Czas świecenia